

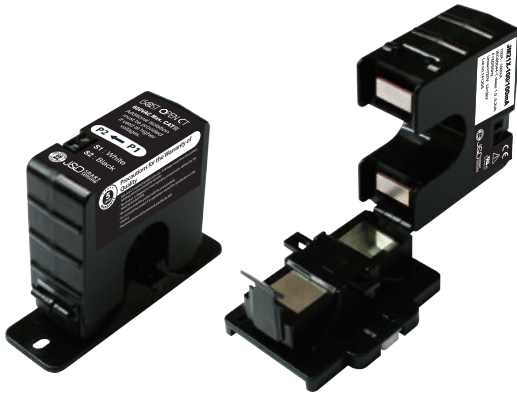

REVENUE-GRADE SPLIT-CORE CURRENT TRANSFORMER JM21X-XXX-100mA series

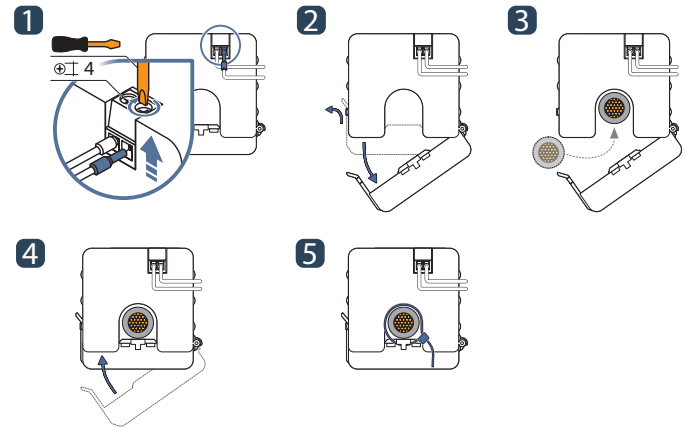

HOW TO USE



JM21X series of split-core current transformer offers 100mA at secondary from sensed primary current. Without using secondary CT inside of meter, users directly connect JM21X series to a meter for high accuracy metering application. It enables one meter to be adopted for various current rating by only changing primary CT so it makes compact design meter and reduces developing cost. Also, over-voltage protection circuit is included to offer safe, fast and cost effective installation.

APPLICATIONS

- Power meter
- Switchgear
- Distributed measurement systems
- General Sets
- Control panels

FEATURES

- Steel spring plate, output-terminal, secure locking hinge, one-touch structure easily to install to existing equipment such as a power distribution board
- Isolated plastic case recognized according to UL94-V0
- UL / EN 61010 - 1 certified

BENEFITS

- Small-size, light-weight
- Simple Installation
- Over-Voltage protection circuit is installed.

NOTICE

- Core contact surface is waterproofed, however if it gets rusty, you could reuse after removing rusts with spraying WD-40 or CRC5-56 on the rusted side
- Do not use any other chemicals except WD-40 or CRC5-56 on housing or any other parts.
- Customizing output lead wire

SPECIFICATION

Accuracy	IEC Class 0.5S / ANSI Class 0.6
Output Terminals	Terminal Block(2P) - PART NUMBER : LM5.08/02/90 SW(black)
System Voltage	720V(0.72kV)
Overload withstand	1.2 times rated current continuously
Compliant with	IEC/EN61869-2, IEEE/ANSI C57.13 & IEC61010-1
Operating Temperature Range	-20°C to 55°C
Relative Humidity	0-85% non-condensing
Latch/Unlatch	about 100 times
Test Voltage	3kV for 1minute
Frequency Range	50/60Hz
Protection Level	5.1V0-P
Insulation Category	CAT II or CATIII 600VAC



CURRENT TRANSFORMER RATIOS / DIMENSIONS

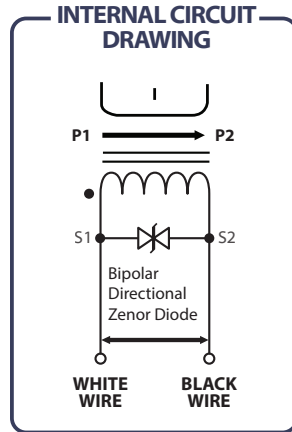
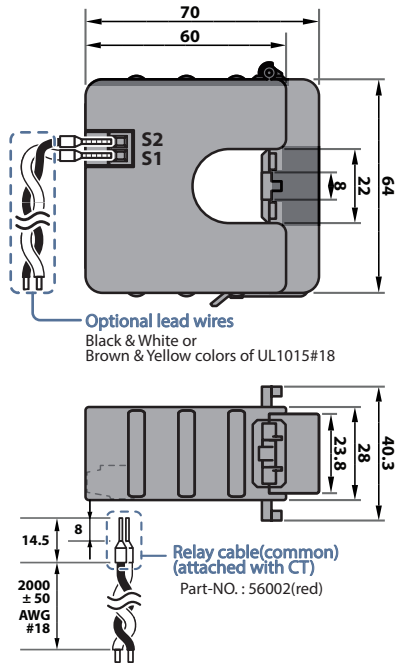

How to Order / Model Reference

eg **JM21X-000/100mA**

Model **J M 2 1 X**

Primary Current

Select code from ratio table

Secondary Current

100mA

1 0 0 mA

Current Transformer Ratios

Primary Current (A)	Metering Burden(VA)				Code
	cl. 0.5S	cl. 1	cl. 3	cl. 2.4	
50	0.01	0.02			050
70	0.01	0.02			070
100	0.01	0.05			100
125	0.01	0.05			125
150	0.01	0.05			150
200	0.05				200
250	0.05				250

100mA Secondary

Accuracy conforms to IEC61869-2 & IEEE/ANSI C57.13 meets the measuring range from 1 to 120% of In

• PANEL MOUNT

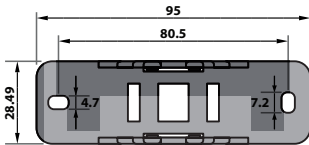

• DIN RAIL MOUNT

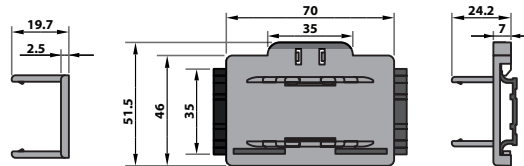

DIN RAIL MOUNTING

Mount the bracket on the rail and install current transformer

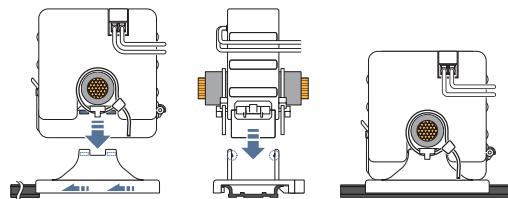
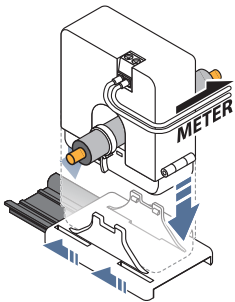

PANEL MOUNTING

Tighten screws on the hole to mount bracket and install current transformer

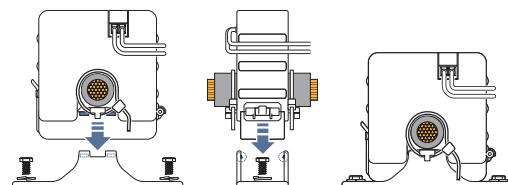
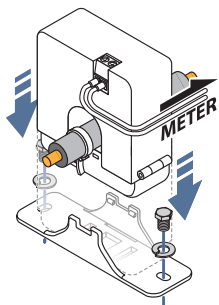

Precautions for the Warranty of Quality

- Split-core CT must be handled with care. A damage caused from the careless handling will not be covered by warranty.
- The product is designed to meet operating environments defined by the industrial standard IP20.
- Be careful to install the product with the correct polarity.
- Do not install the product if an application exceed the specifications of the product.
- Recommended to use the terminals specified by J&D.



Check Point for the Accurate Measurement

- Protection circuit built in inside of the product for user safety. An additional external protection circuit would be impacted on the feature.
- The product is designed for measuring sinusoidal 50/60Hz of primary current. Be aware that it is possible to occur the significant error if it is used to measure non-sinusoidal.
- Use Split-core CT with proper diameter to fit the conductor, otherwise it may cause the ratio error and the phase shift.
- Be careful to install Split-core CT without any pollutions on the core surfaces. The pollutions such as moisture, dust and rusty can be caused the error. After removing the pollutions, recommended to use WD-40 or CRC5-56 on the core surfaces.
- Check whether the secondary leads is connected correctly or not. If the connection is not correctly, the secondary output could be lower than the expected one.



Remarks for the Customized Products

- Please provide the technical requirements for a technical evaluation.
- The color of housing is changeable upon the customer's requirements.
- The leads can be mounted on the terminals by J&D.
- A protective tailor-made housing is available.